

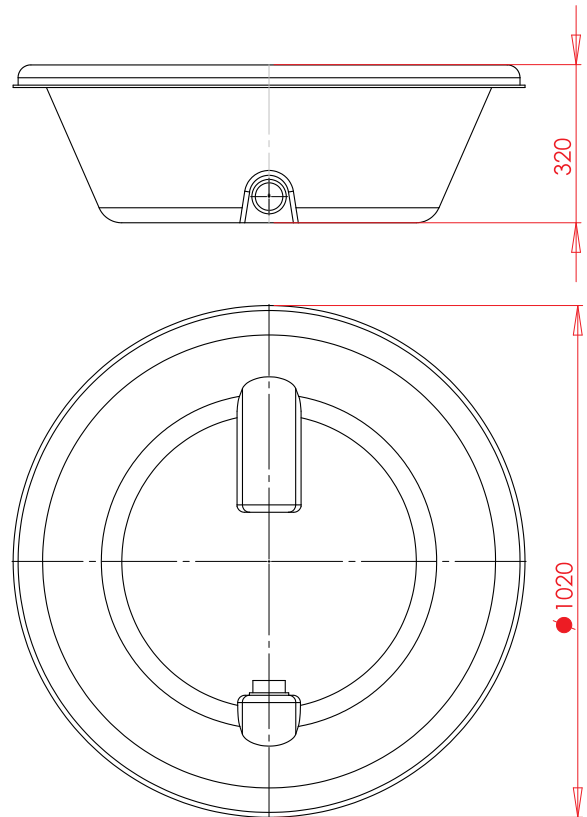

características generales:



- Capacidad 150 litros.
- dimensiones : diámetro 1020mm / alto 320 mm.
- Anidable.
- Totalmente liso, con esquinas redondeadas, fácil de limpiar.
- Borde superior resistente al impacto.
- Fabricado en polietileno virgen de mediana densidad/estabilizado con aditivo anti-UV.
- Tapón para desagüe de 2 pulgadas

Colores Opcionales



AUSTRAL PLASTICS
Chile S.A.

Longitudinal Sur KM.1029 Alto Bonito / Parcela 22
Puerto Montt / Chile
Fono: (56-65) 2560 700 / 560 701
www.australplastics.com

